



AiP74HC/HCT08

Quad 2-input And Gate

Product Specification

Specification Revision History:

Version	Date	Description
2012-05-A1	2012-05	New
2023-04-B1	2023-04	Update the template



Contents

1、 General Description.....	3
2、 Block Diagram And Pin Description	6
2.1、 Block Diagram	6
2.2、 Pin Configurations.....	7
2.3、 Pin Description	7
2.4、 Function Table.....	7
3、 Electrical Parameter	8
3.1、 Absolute Maximum Ratings.....	8
3.2、 Recommended Operating Conditions	8
3.3、 Electrical Characteristics	9
3.3.1、 DC Characteristics 1	9
3.3.2、 DC Characteristics 2	10
3.3.3、 DC Characteristics 3	11
3.3.4、 AC Characteristics 1	12
3.3.5、 AC Characteristics 2	13
3.3.6、 AC Characteristics 3	13
4、 Testing Circuit	14
4.1、 AC Testing Circuit	14
4.2、 AC Testing Waveforms.....	14
4.3、 Measurement Points	15
4.4、 Test Data	15
5、 Package Information	16
5.1、 DIP14	16
5.2、 SOP14	17
5.3、 TSSOP14.....	18
6、 Statements And Notes	19
6.1、 The name and content of Hazardous substances or Elements in the product	19
6.2、 Notes	19



1、 General Description

The AiP74HC/HCT08 is a quad 2-input AND gate. Inputs include clamp diodes. This enables the use of current limiting resistors to interface inputs to voltages in excess of V_{CC} .

Features:

- Input levels:
For AiP74HC08: CMOS level
For AiP74HCT08: TTL level
- Specified from -40°C to +125°C
- Packaging information: DIP14/SOP14/TSSOP14



**Ordering Information:****Tube packing specifications:**

Part number	Packaging form	Marking code	Tube quantity	Boxed tube quantity	Boxed quantity	Notes
AiP74HC08DA14.TB	DIP14	74HC08	25 PCS/tube	40 tube/box	1000 PCS/box	Dimensions of plastic enclosure: 19.0mm×6.4mm Pin spacing: 2.54mm
AiP74HCT08DA14.TB	DIP14	74HCT08	25 PCS/tube	40 tube/box	1000 PCS/box	Dimensions of plastic enclosure: 19.0mm×6.4mm Pin spacing: 2.54mm
AiP74HC08SA14.TB	SOP14	74HC08	50 PCS/tube	200 tube/box	10000 PCS/box	Dimensions of plastic enclosure: 8.7mm×3.9mm Pin spacing: 1.27mm
AiP74HCT08SA14.TB	SOP14	74HCT08	50 PCS/tube	200 tube/box	10000 PCS/box	Dimensions of plastic enclosure: 8.7mm×3.9mm Pin spacing: 1.27mm
AiP74HC08TA14.TB	TSSOP14	74HC08	96 PCS/tube	200 tube/box	19200 PCS/box	Dimensions of plastic enclosure: 5.0mm×4.4mm Pin spacing: 0.65mm
AiP74HCT08TA14.TB	TSSOP14	74HCT08	96 PCS/tube	200 tube/box	19200 PCS/box	Dimensions of plastic enclosure: 5.0mm×4.4mm Pin spacing: 0.65mm



Reel packing specifications:

Part number	Packaging form	Marking code	Reel quantity	Boxed reel quantity	Notes
AiP74HC08SA14.TR	SOP14	74HC08	4000 PCS/reel	8000 PCS/box	Dimensions of plastic enclosure: 8.7mm×3.9mm Pin spacing: 1.27mm
AiP74HCT08SA14.TR	SOP14	74HCT08	4000 PCS/reel	8000 PCS/box	Dimensions of plastic enclosure: 8.7mm×3.9mm Pin spacing: 1.27mm
AiP74HC08TA14.TR	TSSOP14	74HC08	5000 PCS/reel	10000 PCS/box	Dimensions of plastic enclosure: 5.0mm×4.4mm Pin spacing: 0.65mm
AiP74HCT08TA14.TR	TSSOP14	74HCT08	5000 PCS/reel	10000 PCS/box	Dimensions of plastic enclosure: 5.0mm×4.4mm Pin spacing: 0.65mm

Note: If the physical information is inconsistent with the ordering information, please refer to the actual product.



2、Block Diagram And Pin Description

2.1、Block Diagram

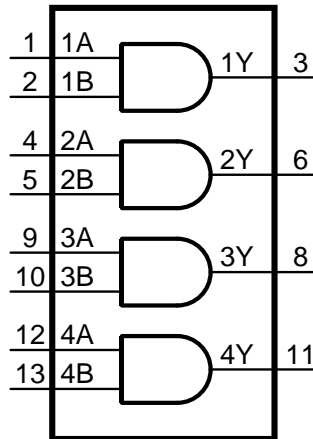

Figure 1. Logic symbol

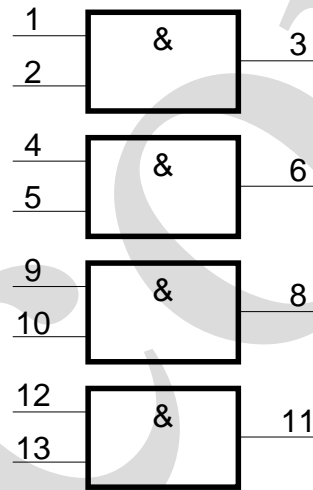

Figure 2. IEC logic symbol

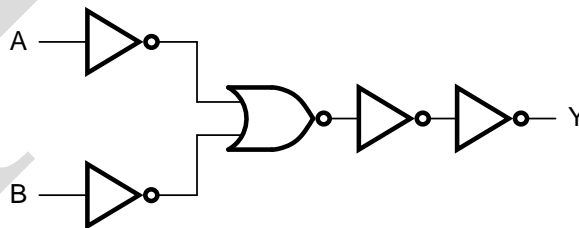
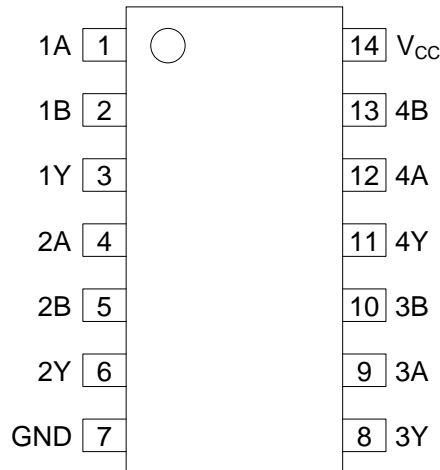

Figure 3. Logic diagram for one gate



2.2、Pin Configurations



2.3、Pin Description

Pin No.	Pin Name	Description
1	1A	data input
2	1B	data input
3	1Y	data output
4	2A	data input
5	2B	data input
6	2Y	data output
7	GND	ground (0V)
8	3Y	data output
9	3A	data input
10	3B	data input
11	4Y	data output
12	4A	data input
13	4B	data input
14	V _{CC}	supply voltage

2.4、Function Table

Input		Output
nA	nB	nY
L	L	L
L	H	L
H	L	L
H	H	H

Note: H=HIGH voltage level; L=LOW voltage level.



3、Electrical Parameter

3.1、Absolute Maximum Ratings

(Voltages are referenced to GND (ground=0V), unless otherwise specified.)

Parameter	Symbol	Conditions	Min.	Max.	Unit
supply voltage	V_{CC}	-	-0.5	+7	V
input clamping current	I_{IK}	$V_I < -0.5V$ or $V_I > V_{CC}+0.5V$	-	± 20	mA
output clamping current	I_{OK}	$V_O < -0.5V$ or $V_O > V_{CC}+0.5V$	-	± 20	mA
output current	I_O	$-0.5V < V_O < V_{CC}+0.5V$	-	± 25	mA
supply current	I_{CC}	-	-	50	mA
ground current	I_{GND}	-	-50	-	mA
total power dissipation	P_{tot}	-	-	500	mW
storage temperature	T_{stg}	-	-65	+150	$^{\circ}C$
Soldering temperature	T_L	10s	DIP	245	$^{\circ}C$
			SOP/TSSOP	260	$^{\circ}C$

3.2、Recommended Operating Conditions

Parameter	Symbol	Conditions	Min.	Typ.	Max.	Unit
AiP74HC08						
supply voltage	V_{CC}	-	2.0	5.0	6.0	V
input voltage	V_I	-	0	-	V_{CC}	V
output voltage	V_O	-	0	-	V_{CC}	V
input transition rise and fall rate	$\Delta t/\Delta V$	$V_{CC}=2.0V$	-	-	625	ns/V
		$V_{CC}=4.5V$	-	1.67	139	ns/V
		$V_{CC}=6.0V$	-	-	83	ns/V
ambient temperature	T_{amb}	-	-40	-	+125	$^{\circ}C$
AiP74HCT08						
supply voltage	V_{CC}	-	4.5	5.0	5.5	V
input voltage	V_I	-	0	-	V_{CC}	V
output voltage	V_O	-	0	-	V_{CC}	V
input transition rise and fall rate	$\Delta t/\Delta V$	$V_{CC}=2.0V$	-	-	-	ns/V
		$V_{CC}=4.5V$	-	1.67	139	ns/V
		$V_{CC}=6.0V$	-	-	-	ns/V
ambient temperature	T_{amb}	-	-40	-	+125	$^{\circ}C$



3.3、Electrical Characteristics

3.3.1、DC Characteristics 1

($T_{amb}=25^{\circ}\text{C}$, voltages are referenced to GND (ground=0V), unless otherwise specified.)

Parameter	Symbol	Conditions	Min.	Typ.	Max.	Unit	
AiP74HC08							
HIGH-level input voltage	V_{IH}	$V_{CC}=2.0\text{V}$	1.5	1.2	-	V	
		$V_{CC}=4.5\text{V}$	3.15	2.4	-	V	
		$V_{CC}=6.0\text{V}$	4.2	3.2	-	V	
LOW-level input voltage	V_{IL}	$V_{CC}=2.0\text{V}$	-	0.8	0.5	V	
		$V_{CC}=4.5\text{V}$	-	2.1	1.35	V	
		$V_{CC}=6.0\text{V}$	-	2.8	1.8	V	
HIGH-level output voltage	V_{OH}	$V_I=V_{IH}$ or V_{IL}	$I_O=-20\mu\text{A}; V_{CC}=2.0\text{V}$	1.9	2.0	-	V
			$I_O=-20\mu\text{A}; V_{CC}=4.5\text{V}$	4.4	4.5	-	V
			$I_O=-20\mu\text{A}; V_{CC}=6.0\text{V}$	5.9	6.0	-	V
			$I_O=-4.0\text{mA}; V_{CC}=4.5\text{V}$	3.98	4.32	-	V
			$I_O=-5.2\text{mA}; V_{CC}=6.0\text{V}$	5.48	5.81	-	V
LOW-level output voltage	V_{OL}	$V_I=V_{IH}$ or V_{IL}	$I_O=20\mu\text{A}; V_{CC}=2.0\text{V}$	-	0	0.1	V
			$I_O=20\mu\text{A}; V_{CC}=4.5\text{V}$	-	0	0.1	V
			$I_O=20\mu\text{A}; V_{CC}=6.0\text{V}$	-	0	0.1	V
			$I_O=4.0\text{mA}; V_{CC}=4.5\text{V}$	-	0.15	0.26	V
			$I_O=5.2\text{mA}; V_{CC}=6.0\text{V}$	-	0.16	0.26	V
input leakage current	I_I	$V_I=V_{CC}$ or GND; $V_{CC}=6.0\text{V}$	-	-	± 1	μA	
supply current	I_{CC}	$V_I=V_{CC}$ or GND; $I_O=0\text{A}$; $V_{CC}=6.0\text{V}$	-	-	2.0	μA	
input capacitance	C_I	-	-	3.5	-	pF	
AiP74HCT08							
HIGH-level input voltage	V_{IH}	$V_{CC}=4.5\text{V}$ to 5.5V	2.0	1.6	-	V	
LOW-level input voltage	V_{IL}	$V_{CC}=4.5\text{V}$ to 5.5V	-	1.2	0.8	V	
HIGH-level output voltage	V_{OH}	$V_I=V_{IH}$ or V_{IL}	$I_O=-20\mu\text{A}; V_{CC}=4.5\text{V}$	4.4	4.5	-	V
			$I_O=-4.0\text{mA}; V_{CC}=4.5\text{V}$	3.98	4.32	-	V
LOW-level output voltage	V_{OL}	$V_I=V_{IH}$ or V_{IL}	$I_O=20\mu\text{A}; V_{CC}=4.5\text{V}$	-	0	0.1	V
			$I_O=5.2\text{mA}; V_{CC}=4.5\text{V}$	-	0.15	0.26	V
input leakage current	I_I	$V_I=V_{CC}$ or GND; $V_{CC}=6.0\text{V}$	-	-	± 1	μA	
supply current	I_{CC}	$V_I=V_{CC}$ or GND; $I_O=0\text{A}$; $V_{CC}=5.5\text{V}$	-	-	2.0	μA	
additional supply current	ΔI_{CC}	per input pin; $V_I=V_{CC}-2.1\text{V}$; $I_O=0\text{A}$; other inputs at V_{CC} or GND; $V_{CC}=4.5\text{V}$ to 5.5V	-	-	216	μA	
input capacitance	C_I	-	-	3.5	-	pF	



3.3.2、DC Characteristics 2

($T_{amb}=-40^{\circ}\text{C}$ to $+85^{\circ}\text{C}$, voltages are referenced to GND (ground=0V), unless otherwise specified.)

Parameter	Symbol	Conditions	Min.	Typ.	Max.	Unit	
AiP74HC08							
HIGH-level input voltage	V_{IH}	$V_{CC}=2.0\text{V}$	1.5	-	-	V	
		$V_{CC}=4.5\text{V}$	3.15	-	-	V	
		$V_{CC}=6.0\text{V}$	4.2	-	-	V	
LOW-level input voltage	V_{IL}	$V_{CC}=2.0\text{V}$	-	-	0.5	V	
		$V_{CC}=4.5\text{V}$	-	-	1.35	V	
		$V_{CC}=6.0\text{V}$	-	-	1.8	V	
HIGH-level output voltage	V_{OH}	$V_I=V_{IH}$ or V_{IL}	$I_O=-20\mu\text{A}; V_{CC}=2.0\text{V}$	1.9	-	-	V
			$I_O=-20\mu\text{A}; V_{CC}=4.5\text{V}$	4.4	-	-	V
			$I_O=-20\mu\text{A}; V_{CC}=6.0\text{V}$	5.9	-	-	V
			$I_O=-4.0\text{mA}; V_{CC}=4.5\text{V}$	3.84	-	-	V
			$I_O=-5.2\text{mA}; V_{CC}=6.0\text{V}$	5.34	-	-	V
LOW-level output voltage	V_{OL}	$V_I=V_{IH}$ or V_{IL}	$I_O=20\mu\text{A}; V_{CC}=2.0\text{V}$	-	-	0.1	V
			$I_O=20\mu\text{A}; V_{CC}=4.5\text{V}$	-	-	0.1	V
			$I_O=20\mu\text{A}; V_{CC}=6.0\text{V}$	-	-	0.1	V
			$I_O=4.0\text{mA}; V_{CC}=4.5\text{V}$	-	-	0.33	V
			$I_O=5.2\text{mA}; V_{CC}=6.0\text{V}$	-	-	0.33	V
input leakage current	I_I	$V_I=V_{CC}$ or GND; $V_{CC}=6.0\text{V}$	-	-	± 1	μA	
supply current	I_{CC}	$V_I=V_{CC}$ or GND; $I_O=0\text{A}$; $V_{CC}=6.0\text{V}$	-	-	20	μA	
AiP74HCT08							
HIGH-level input voltage	V_{IH}	$V_{CC}=4.5\text{V}$ to 5.5V	2.0	-	-	V	
LOW-level input voltage	V_{IL}	$V_{CC}=4.5\text{V}$ to 5.5V	-	-	0.8	V	
HIGH-level output voltage	V_{OH}	$V_I=V_{IH}$ or V_{IL}	$I_O=-20\mu\text{A}; V_{CC}=4.5\text{V}$	4.4	-	-	V
			$I_O=-4.0\text{mA}; V_{CC}=4.5\text{V}$	3.84	-	-	V
LOW-level output voltage	V_{OL}	$V_I=V_{IH}$ or V_{IL}	$I_O=20\mu\text{A}; V_{CC}=4.5\text{V}$	-	-	0.1	V
			$I_O=5.2\text{mA}; V_{CC}=4.5\text{V}$	-	-	0.33	V
input leakage current	I_I	$V_I=V_{CC}$ or GND; $V_{CC}=6.0\text{V}$	-	-	± 1	μA	
supply current	I_{CC}	$V_I=V_{CC}$ or GND; $I_O=0\text{A}$; $V_{CC}=5.5\text{V}$	-	-	20	μA	
additional supply current	ΔI_{CC}	per input pin; $V_I=V_{CC}-2.1\text{V}$; $I_O=0\text{A}$; other inputs at V_{CC} or GND; $V_{CC}=4.5\text{V}$ to 5.5V	-	-	270	μA	



3.3.3、DC Characteristics 3

($T_{amb} = -40^{\circ}\text{C}$ to $+125^{\circ}\text{C}$, voltages are referenced to GND (ground=0V), unless otherwise specified.)

Parameter	Symbol	Conditions	Min.	Typ.	Max.	Unit	
AiP74HC08							
HIGH-level input voltage	V_{IH}	$V_{CC}=2.0\text{V}$	1.5	-	-	V	
		$V_{CC}=4.5\text{V}$	3.15	-	-	V	
		$V_{CC}=6.0\text{V}$	4.2	-	-	V	
LOW-level input voltage	V_{IL}	$V_{CC}=2.0\text{V}$	-	-	0.5	V	
		$V_{CC}=4.5\text{V}$	-	-	1.35	V	
		$V_{CC}=6.0\text{V}$	-	-	1.8	V	
HIGH-level output voltage	V_{OH}	$V_I = V_{IH}$ or V_{IL}	$I_O = -20\mu\text{A}; V_{CC} = 2.0\text{V}$	1.9	-	-	V
			$I_O = -20\mu\text{A}; V_{CC} = 4.5\text{V}$	4.4	-	-	V
			$I_O = -20\mu\text{A}; V_{CC} = 6.0\text{V}$	5.9	-	-	V
			$I_O = -4.0\text{mA}; V_{CC} = 4.5\text{V}$	3.7	-	-	V
			$I_O = -5.2\text{mA}; V_{CC} = 6.0\text{V}$	5.2	-	-	V
LOW-level output voltage	V_{OL}	$V_I = V_{IH}$ or V_{IL}	$I_O = 20\mu\text{A}; V_{CC} = 2.0\text{V}$	-	-	0.1	V
			$I_O = 20\mu\text{A}; V_{CC} = 4.5\text{V}$	-	-	0.1	V
			$I_O = 20\mu\text{A}; V_{CC} = 6.0\text{V}$	-	-	0.1	V
			$I_O = 4.0\text{mA}; V_{CC} = 4.5\text{V}$	-	-	0.4	V
			$I_O = 5.2\text{mA}; V_{CC} = 6.0\text{V}$	-	-	0.4	V
input leakage current	I_I	$V_I = V_{CC}$ or GND; $V_{CC} = 6.0\text{V}$	-	-	± 1	μA	
supply current	I_{CC}	$V_I = V_{CC}$ or GND; $I_O = 0\text{A}$; $V_{CC} = 6.0\text{V}$	-	-	40	μA	
AiP74HCT08							
HIGH-level input voltage	V_{IH}	$V_{CC} = 4.5\text{V}$ to 5.5V	2.0	-	-	V	
LOW-level input voltage	V_{IL}	$V_{CC} = 4.5\text{V}$ to 5.5V	-	-	0.8	V	
HIGH-level output voltage	V_{OH}	$V_I = V_{IH}$ or V_{IL}	$I_O = -20\mu\text{A}; V_{CC} = 4.5\text{V}$	4.4	-	-	V
			$I_O = -4.0\text{mA}; V_{CC} = 4.5\text{V}$	3.7	-	-	V
LOW-level output voltage	V_{OL}	$V_I = V_{IH}$ or V_{IL}	$I_O = 20\mu\text{A}; V_{CC} = 4.5\text{V}$	-	-	0.1	V
			$I_O = 5.2\text{mA}; V_{CC} = 4.5\text{V}$	-	-	0.4	V
input leakage current	I_I	$V_I = V_{CC}$ or GND; $V_{CC} = 6.0\text{V}$	-	-	± 1	μA	
supply current	I_{CC}	$V_I = V_{CC}$ or GND; $I_O = 0\text{A}$; $V_{CC} = 5.5\text{V}$	-	-	40	μA	
additional supply current	ΔI_{CC}	per input pin; $V_I = V_{CC} - 2.1\text{V}$; $I_O = 0\text{A}$; other inputs at V_{CC} or GND; $V_{CC} = 4.5\text{V}$ to 5.5V	-	-	294	μA	



3.3.4. AC Characteristics 1

($T_{amb}=25^{\circ}C$, voltages are referenced to GND (ground=0V), unless otherwise specified.)

Parameter	Symbol	Conditions	Min.	Typ.	Max.	Unit	
AiP74HC08							
nA, nB to nY propagation delay	t_{pd}	see Figure 5 ^[1]	$V_{CC}=2.0V$	-	25	90	ns
			$V_{CC}=4.5V$	-	9	18	ns
			$V_{CC}=5.0V; C_L=15pF$	-	7	-	ns
			$V_{CC}=6.0V$	-	7	15	ns
transition time	t_t	see Figure 5 ^[2]	$V_{CC}=2.0V$	-	19	75	ns
			$V_{CC}=4.5V$	-	7	15	ns
			$V_{CC}=6.0V$	-	6	13	ns
power dissipation capacitance	C_{PD}	per package; $V_I=GND$ to V_{CC} ^[3]	-	10	-	pF	
AiP74HCT08							
nA, nB to nY propagation delay	t_{pd}	see Figure 5 ^[1]	$V_{CC}=4.5V$	-	14	24	ns
			$V_{CC}=5.0V; C_L=15pF$	-	11	-	ns
transition time	t_t	see Figure 5 ^[2]	$V_{CC}=4.5V$	-	7	15	ns
power dissipation capacitance	C_{PD}	per package; $V_I=GND$ to $V_{CC}-1.5V$ ^[3]	-	20	-	pF	

Note:

[1] t_{pd} is the same as t_{PLH} and t_{PHL} .

[2] t_t is the same as t_{THL} and t_{TLH} .

[3] C_{PD} is used to determine the dynamic power dissipation (P_D in uW).

$$P_D=(C_{PD} \times V_{CC}^2 \times f_i \times N) + \sum(C_L \times V_{CC}^2 \times f_o) \text{ where:}$$

f_i =input frequency in MHz;

f_o =output frequency in MHz;

C_L =output load capacitance in pF;

V_{CC} =supply voltage in V;

N =number of inputs switching;

$\sum(C_L \times V_{CC}^2 \times f_o)$ =sum of outputs.



3.3.5、AC Characteristics 2

($T_{amb}=-40^{\circ}\text{C}$ to $+85^{\circ}\text{C}$, voltages are referenced to GND (ground=0V), unless otherwise specified.)

Parameter	Symbol	Conditions	Min.	Typ.	Max.	Unit	
AiP74HC08							
nA, nB to nY propagation delay	t_{pd}	see Figure 5 ^[1]	$V_{CC}=2.0\text{V}$	-	-	115	ns
			$V_{CC}=4.5\text{V}$	-	-	23	ns
			$V_{CC}=6.0\text{V}$	-	-	20	ns
transition time	t_t	see Figure 5 ^[2]	$V_{CC}=2.0\text{V}$	-	-	95	ns
			$V_{CC}=4.5\text{V}$	-	-	19	ns
			$V_{CC}=6.0\text{V}$	-	-	16	ns
AiP74HCT08							
nA, nB to nY propagation delay	t_{pd}	see Figure 5 ^[1]	$V_{CC}=4.5\text{V}$	-	-	30	ns
transition time	t_t	see Figure 5 ^[2]	$V_{CC}=4.5\text{V}$	-	-	19	ns

Note:

[1] t_{pd} is the same as t_{PLH} and t_{PHL} .

[2] t_t is the same as t_{THL} and t_{TLH} .

3.3.6、AC Characteristics 3

($T_{amb}=-40^{\circ}\text{C}$ to $+125^{\circ}\text{C}$, voltages are referenced to GND (ground=0V), unless otherwise specified.)

Parameter	Symbol	Conditions	Min.	Typ.	Max.	Unit	
AiP74HC08							
nA, nB to nY propagation delay	t_{pd}	see Figure 5 ^[1]	$V_{CC}=2.0\text{V}$	-	-	135	ns
			$V_{CC}=4.5\text{V}$	-	-	27	ns
			$V_{CC}=6.0\text{V}$	-	-	23	ns
transition time	t_t	see Figure 5 ^[2]	$V_{CC}=2.0\text{V}$	-	-	110	ns
			$V_{CC}=4.5\text{V}$	-	-	22	ns
			$V_{CC}=6.0\text{V}$	-	-	19	ns
AiP74HCT08							
nA, nB to nY propagation delay	t_{pd}	see Figure 5 ^[1]	$V_{CC}=4.5\text{V}$	-	-	36	ns
transition time	t_t	see Figure 5 ^[2]	$V_{CC}=4.5\text{V}$	-	-	22	ns

Note:

[1] t_{pd} is the same as t_{PLH} and t_{PHL} .

[2] t_t is the same as t_{THL} and t_{TLH} .



4、Testing Circuit

4.1、AC Testing Circuit

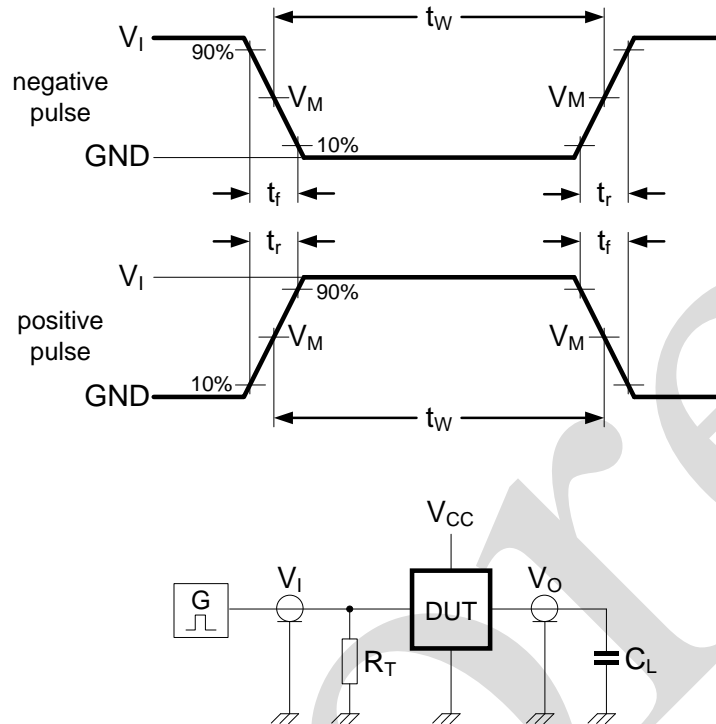

Figure 4. Test circuit for measuring switching times

Definitions for test circuit:

C_L =load capacitance including jig and probe capacitance.

R_T =termination resistance should be equal to the output impedance Z_o of the pulse generator.

4.2、AC Testing Waveforms

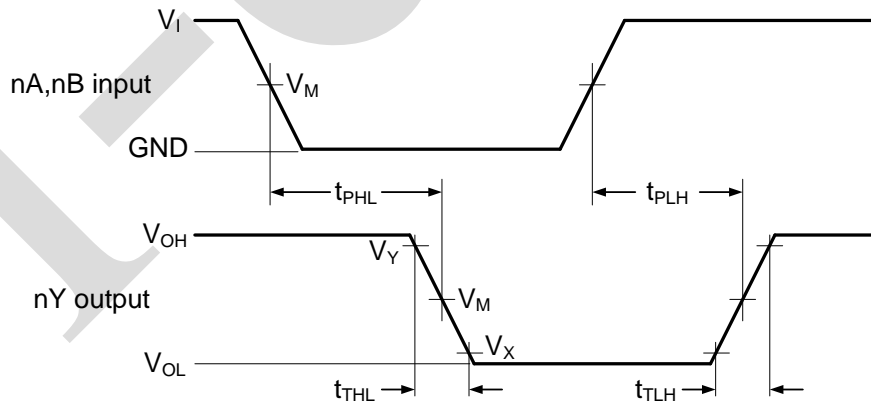

Figure 5. Input to output propagation delays



4.3、Measurement Points

Type	Input	Output		
	V_M	V_M	V_X	V_Y
AiP74HC08	$0.5 \times V_{CC}$	$0.5 \times V_{CC}$	$0.1 \times V_{CC}$	$0.9 \times V_{CC}$
AiP74HCT08	1.3V	1.3V	$0.1 \times V_{CC}$	$0.9 \times V_{CC}$

4.4、Test Data

Type	Input		Load	Test
	V_I	t_r, t_f	C_L	
AiP74HC08	V_{CC}	6.0ns	15pF, 50pF	t_{PLH}, t_{PHL}
AiP74HCT08	3.0V	6.0ns	15pF, 50pF	t_{PLH}, t_{PHL}



5、Package Information

5.1、DIP14

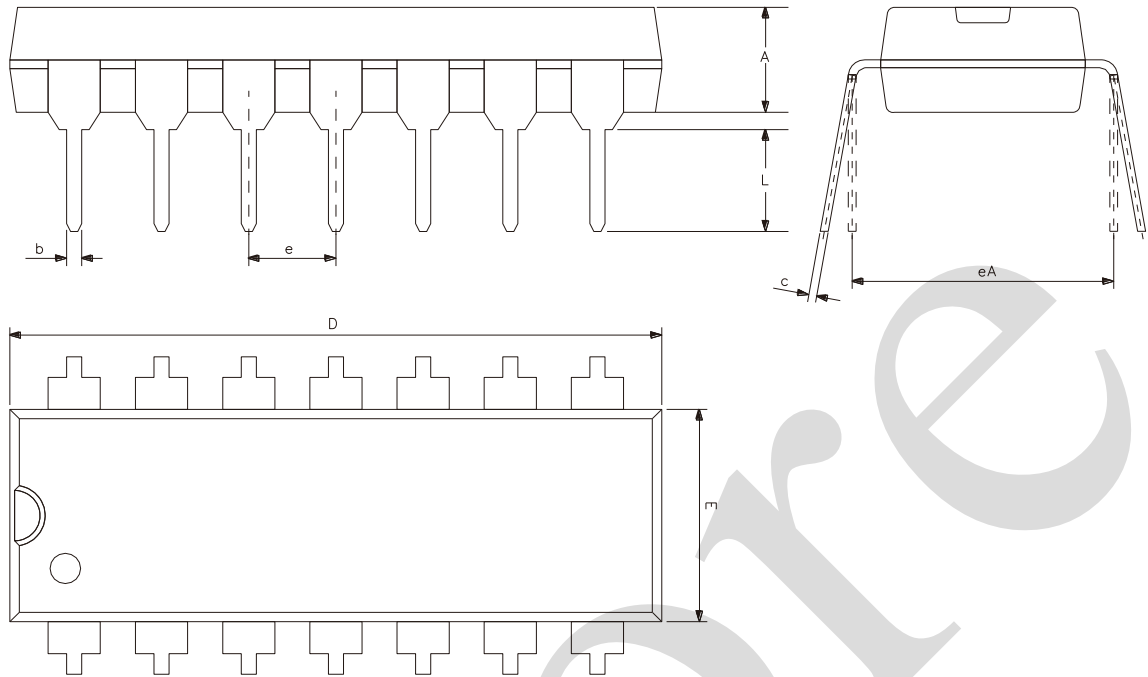

Symbol	Dimensions (mm)	
	Min.	Max.
A	3.05	3.60
b	0.33	0.56
c	0.20	0.36
D	18.80	19.40
E	6.20	6.60
e	2.54	
eA	7.62	10.90
L	2.92	-



5.2、SOP14

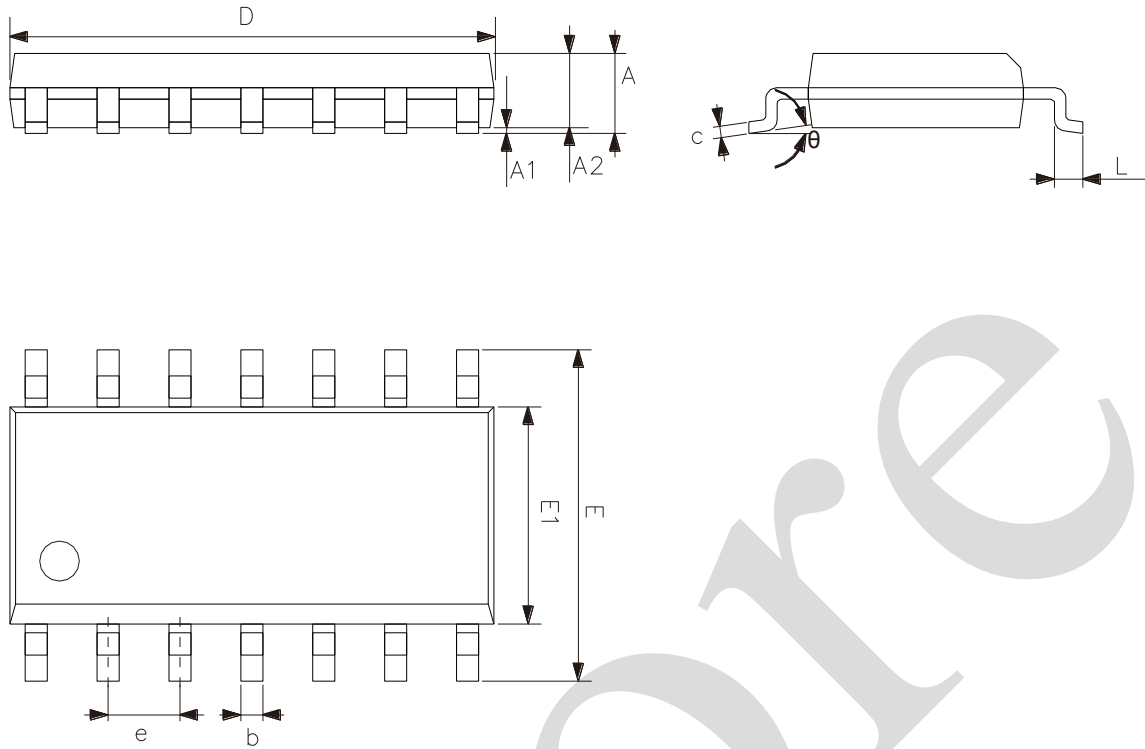

Symbol	Dimensions (mm)	
	Min.	Max.
A	1.50	1.75
A1	0.05	0.25
A2	1.30	-
b	0.33	0.50
c	0.19	0.25
D	8.43	8.76
E	5.80	6.25
E1	3.75	4.00
e	1.27	
L	0.40	0.89
θ	0°	8°



5.3、TSSOP14

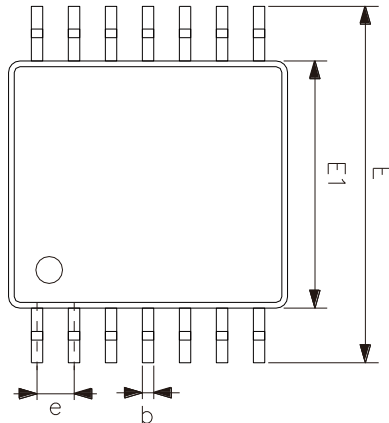
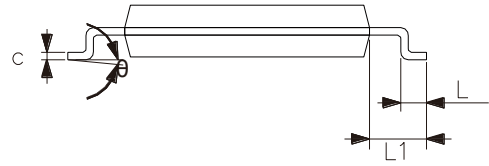
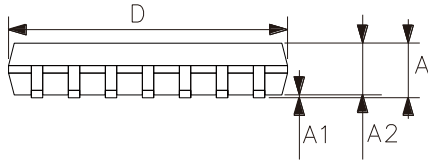

Symbol	Dimensions (mm)	
	Min.	Max.
A	-	1.20
A1	0.05	0.15
A2	0.80	1.05
b	0.19	0.30
c	0.09	0.20
D	4.90	5.10
E1	4.30	4.50
E	6.20	6.60
e	0.65	
L	0.45	0.75
L1	1.00	
θ	0°	8°



6、 Statements And Notes

6.1、 The name and content of Hazardous substances or Elements in the product

Part name	Hazardous substances or Elements									
	Lead and lead compounds	Mercury and mercury compounds	Cadmium and cadmium compounds	Hexavalent chromium compounds	Polybrominated biphenyls	Polybrominated biphenyl ethers	Dibutyl phthalate	Butylbenzyl phthalate	Di-2-ethylhexyl phthalate	Diisobutyl phthalate
Lead frame	○	○	○	○	○	○	○	○	○	○
Plastic resin	○	○	○	○	○	○	○	○	○	○
Chip	○	○	○	○	○	○	○	○	○	○
The lead	○	○	○	○	○	○	○	○	○	○
Plastic sheet installed	○	○	○	○	○	○	○	○	○	○
explanation	○: Indicates that the content of hazardous substances or elements in the detection limit of the following the SJ/T11363-2006 standard. ×: Indicates that the content of hazardous substances or elements exceeding the SJ/T11363-2006 Standard limit requirements.									

6.2、 Notes

We Recommend you to read this chapter carefully before using this product.

The information in this chapter is provided for reference only and i-Core disclaims any express or implied warranties, including but not limited to applicability, special application or non-infringement of third party rights.

This product is not suitable for critical equipment such as life-saving, life-sustaining or safety equipment. It is also not suitable for applications that may result in personal injury, death, or serious property or environmental damage due to product malfunction or failure. I-Core will not be liable for any damages incurred by the customers at their own risk for such applications.

The customer is responsible for conducting all necessary tests i-Core's application to avoid failure in the application or the application of the customer's third party users. I-Core does not accept any liability.

The Company reserves the right to change or improve the information published in this chapter at any time.

The information in this chapter are subject to change without notice. We recommend the customer to consult our sales staff before purchasing.

Please obtain related materials form i-Core's regular channels and we are not responsible for its content if it is provided by sources other than our company.

In case of any conflict between the Chinese and English version, the version is subject to the Chinese one.